



Simulation Software R&S WinIQSIM™

... ideal for the generation of digitally modulated signals

- ◆ Calculation of digitally modulated I/Q and IF signals
- ◆ For driving the I/Q Modulation Generator R&S AMIQ and the internal arbitrary waveform generator of the R&S SMIQ (R&S SMIQB60)
- ◆ Single-carrier, multicarrier, multicarrier mixed signals and CDMA signals
- ◆ WCDMA 3GPP FDD mode including data sets for the test models to 3GPP
- ◆ WCDMA 3GPP TDD mode optional (R&S AMIQ13/R&S SMIQ13)
- ◆ TD-SCDMA optional (R&S AMIQ14/R&S SMIQ14)
- ◆ IS-95 CDMA optional (R&S AMIQ11/R&S SMIQ11)
- ◆ CDMA2000 optional (R&S AMIQ12/R&S SMIQ12)
- ◆ Versatile data editor
- ◆ Superposition/simulation of impairments
- ◆ Graphical display
- ◆ Can be enhanced by import interface for additional software
- ◆ 1xEV-DO optional (R&S AMIQ17/R&S SMIQ17)
- ◆ IEEE 802.11b optional (R&S AMIQ16/R&S SMIQ16)
- ◆ IEEE 802.11a optional (R&S AMIQ18/R&S SMIQ18)



ROHDE & SCHWARZ

It has never been so easy

R&S WinIQSIM™ was especially developed for the generation of digitally modulated signals. Complex signals can thus easily be generated. The graphical user interface allows intuitive operation, supported by context-sensitive help. The convenient way of creating any TDMA frame configurations with the aid of a data editor, and the generation of multicarrier signals as well as of complex WCDMA signals make R&S WinIQSIM™ suitable for a wide range of applications. Moreover, additive impairments can be superimposed on a signal.

The signals generated with the aid of the R&S WinIQSIM™ software can be output by the Arbitrary Waveform Generator R&S AMIQ and the integrated solution in the R&S SMIQ (option R&S SMIQB60). R&S WinIQSIM™ is provided with these two arbitrary waveform generators free of charge.

Install it and go ahead (1)

In developing R&S WinIQSIM™, great importance was attached to user-friendly operation. The main parameters of a signal, for example, are indicated in a status line. The context-sensitive online help enables handling of even complex functions without consulting the manual.

The program always starts with the settings of the previous session, thus ensuring easy continuation of work.

Single carrier (2, 3)

Modulation parameters such as type of modulation, coding, symbol rate, filter and window functions as well as oversampling can be set for a single-carrier signal.

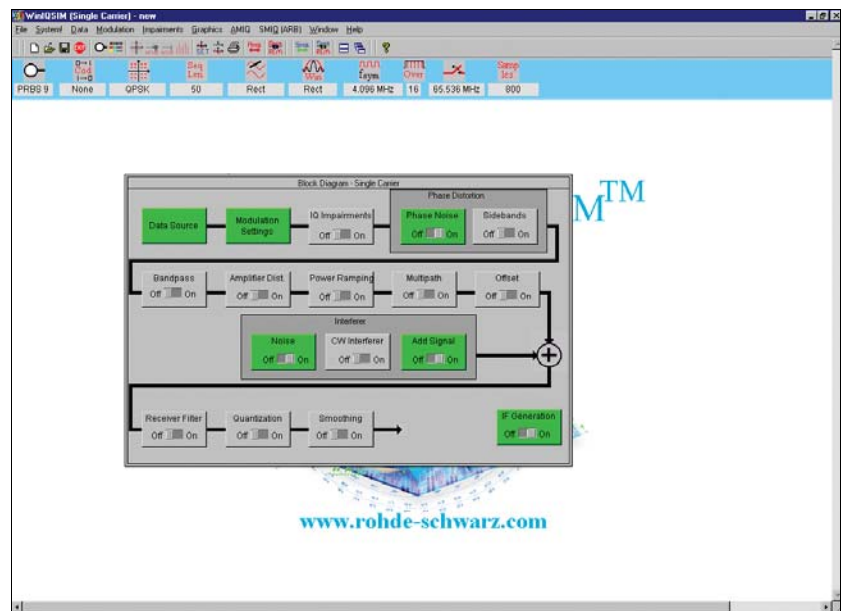

Clearly structured menus in the form of a signal flow chart

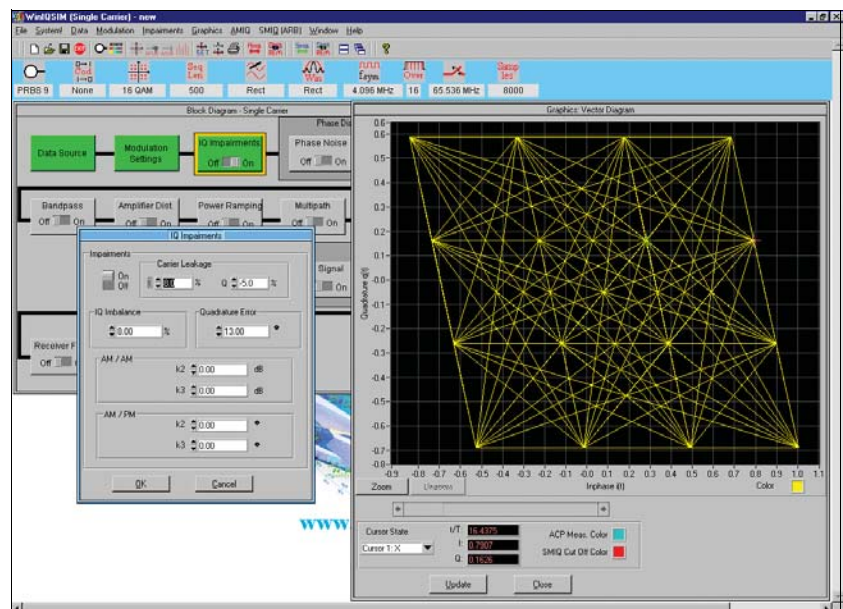

Simulation of I/Q impairments, here for 16QAM

Impairments which may be caused by a real I/Q modulator are also taken into consideration. It is, for example, easy to simulate I/Q imbalance, carrier leakage or quadrature error. The simulation of VCO noise or phase and frequency offsets of

an oscillator are some of the very special features of R&S WinIQSIM™. These and many other settings enable the user to take real impairments into account early in the development phase of components and modules.

WCDMA, CDMA (4 to 11b)

The comprehensive functionality of R&S WinIQSIM™ allows various WCDMA systems to be realized: for example, both modes of the 3GPP standard, FDD (frequency division duplex) and TDD (time division duplex), are implemented. Signals can likewise be generated in accordance with the TD-SCDMA standard. And the North-American standards CDMA2000 and IS-95 are also included in R&S WinIQSIM™.

All data and control channels defined by the relevant standard are supported. These include the synchronization channels such as primary and secondary common control channel (P-CCPCH and S-CCPCH) or synchronization channels (P-SCH and S-PCH).

For the WCDMA standards as well as for the IS-95 and CDMA2000 standards, the orthogonal codes, data sources (PRBS, pattern or user-programmable sequences), and the power of the individual code channels can be varied, so that a large variety of signals can be generated.

R&S WinIQSIM™ provides various display modes for visualizing the settings. The code domain display shows the distribution and occupancy of the individual channels in the code domain. Any code domain conflicts can be automatically resolved by a click. The channel graph includes all active channels. Synchronization and special channels are shown in red; data channels in green.

For statistical evaluation of the CDMA signal characteristics, R&S WinIQSIM™ allows the complementary cumulative distribution function (CCDF) to be calculated (including the crest factor) and graphically displayed. In addition, the resulting adjacent-channel power can be calculated.

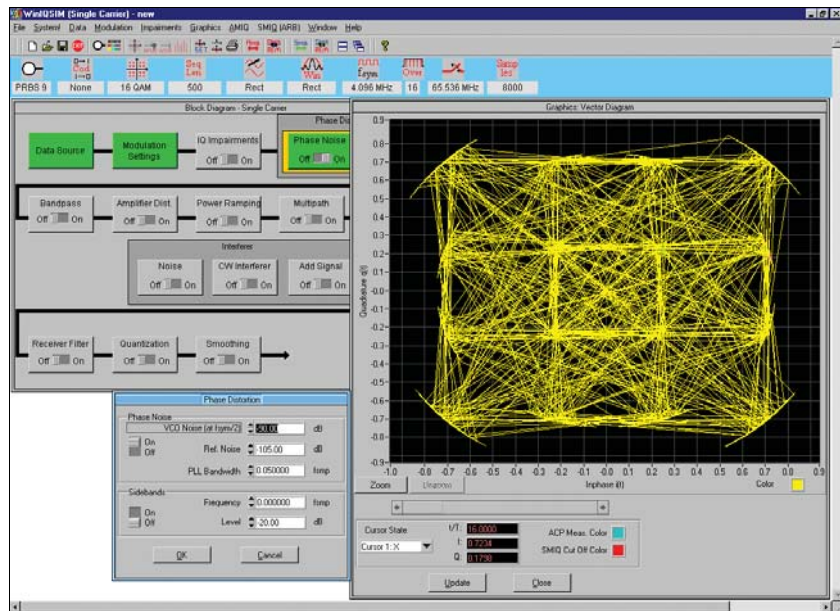

Simulation of defined phase noise on a 16QAM-modulated signal



Definition of a code channel scenario for WCDMA 3GPP FDD mode

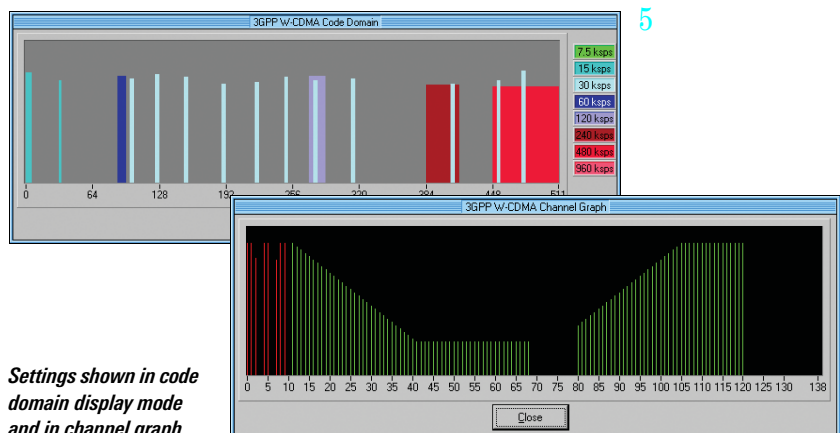

Settings shown in code domain display mode and in channel graph

Depending on the selected symbol rate, up to 512 code channels with a chip rate of 3.84 Mcps are generated in the FDD mode for testing base stations under realistic as well as under worst-case conditions.

For this purpose, signals are generated which contain up to four mobile or base stations with different scrambling codes. R&S WinIQSIM™ also allows the power of the individual data channels to be varied via TPC (transmit power control), which is used to control the power of the different channels in line with the 3GPP standard.

R&S WinIQSIM™ supports the antenna diversity schemes specified by the 3GPP standard. Either the specification for antenna 1 or that for antenna 2 can be used so that the signal will be generated in line with the 3GPP specification.

In the uplink, the mobile station can operate in one of the three permitted modes: PRACH only (physical random access channel), PCPCH only (physical common packet channel) and DPCH + DPDCH (dedicated physical control channel and dedicated physical data channel).

The versatile settings enable even very specific tests to be carried out. For 3GPP FDD, for example, the compressed mode is supported, which allows hand-over of a mobile station from a 3GPP FDD base station to a base station (3GPP FDD, 3GPP TDD or GSM) with a different frequency. For this purpose, transmission and reception of the 3GPP FDD signal has to be interrupted for a certain time. In this transmission gap, the mobile station can change to the frequency of the potential new base station in order to read, for example, the system information or the receive level of this base station. To allow the same data quantity to be transmitted in the remaining shorter time, data is compressed. R&S WinIQSIM™ allows extensive user-defined settings for all

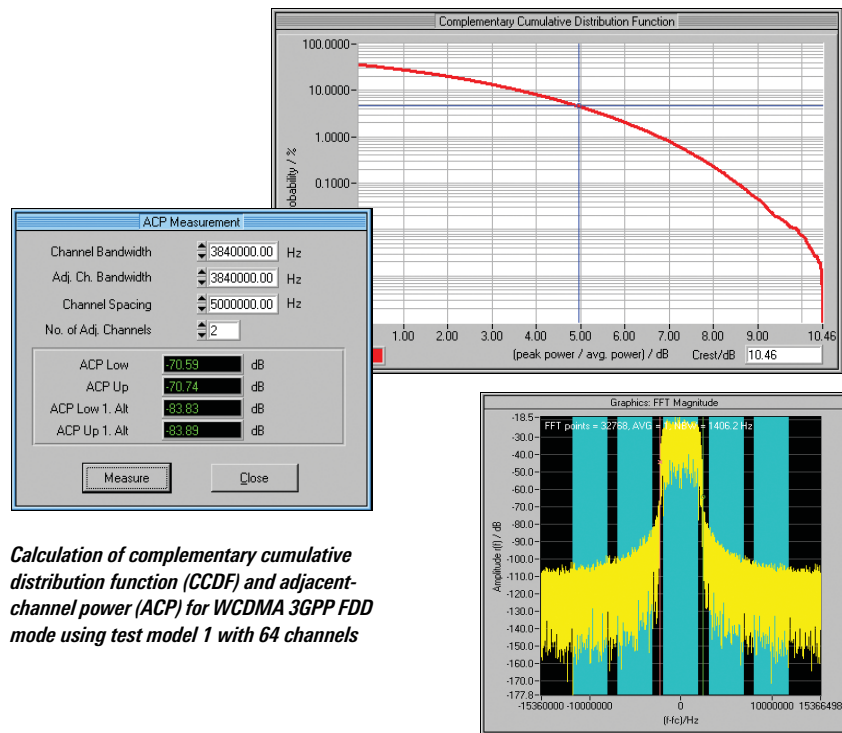

Calculation of complementary cumulative distribution function (CCDF) and adjacent-channel power (ACP) for WCDMA 3GPP FDD mode using test model 1 with 64 channels

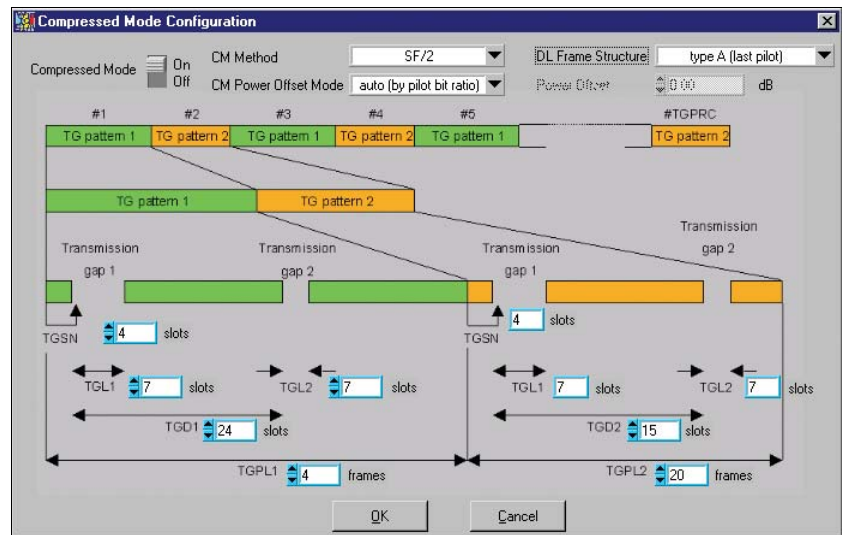

Editing of compressed mode

physical layer compressed mode parameters.

In the TDD mode of the 3GPP standard, the link directions of the individual slots can be conveniently selected. The user can define whether each timeslot is to act as an uplink or a downlink.

Up to four cells with 15 timeslots each can be generated; different spreading factors are permitted for each channel.

For the data channels (DPCH), all spreading factors permitted by the standard are available.

In the TDD mode, it is very important to calculate the CCDF not only for the total signal, but also for a specific timeslot. Since the system is made up of timeslots that can be switched on or off independently of one another, only the CCDF of an active slot is often of interest. This can then be used, for example, to optimally

design the output amplifier of a mobile phone, since the latter is active in one slot only.

TD-SCDMA is basically similar to the 3GPP TDD mode. The two modes differ in the chip rate, which is 1.28 Mcps for TD-SCDMA instead of 3.84 Mcps in the TDD mode. According to the TD-SCDMA standard, the link direction of the individual slots cannot be selected by the user as conveniently as in the 3GPP TDD mode, a fact that has been taken into account by R&S WinIQSIM™.

With TD-SCDMA, special timeslots are provided for the uplink and the downlink. To carry out certain tests on mobile stations, only the downlink pilot may be active, however. R&S WinIQSIM™ considers this fact by generating the downlink signals only.

With IS-95, the previous US standard for CDMA technology is included in R&S WinIQSIM™. With CDMA2000, the following generation of the US standard has also been implemented. R&S WinIQSIM™ supports the modes 1X with 1.2288 Mcps and 3X with 3.6864 Mcps; the 3X mode can optionally be generated according to the direct-spread or multicarrier method. Up to four mobile or base stations can be simulated simultaneously. The same applies to the 1xEV-DO standard (see Fig. 11a, page 6), which represents a further development of the CDMA2000 1x mode and is also supported by R&S WinIQSIM™. 1xEV-DO stands for CDMA2000 1x Evolution Data Only. This standard enables packet-oriented data transfer at a rate of up to 2.4 Mbps in a 1.25 MHz CDMA2000 1x channel.

The open software concept of R&S WinIQSIM™ allows continuous adaptation to the rapid development of third-generation mobile radio standards. The user is thus always up to the state of the art.

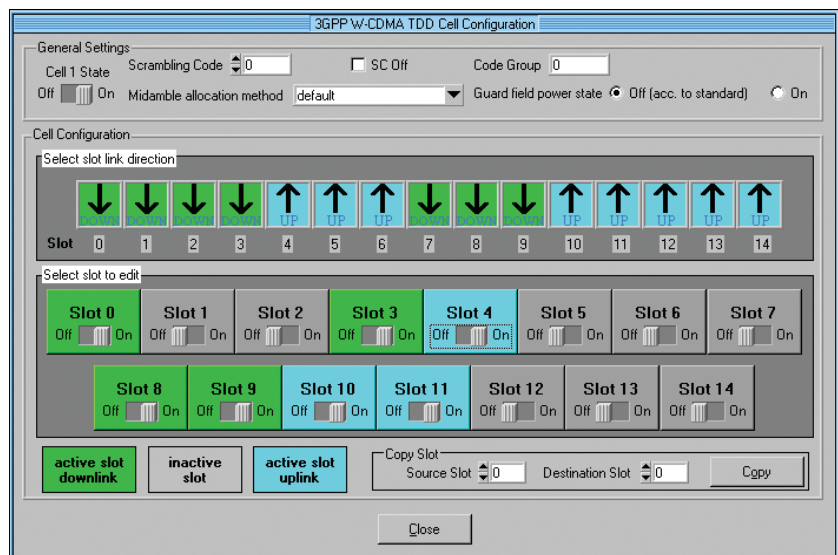

User-defined settings of the timeslots for 3GPP TDD mode

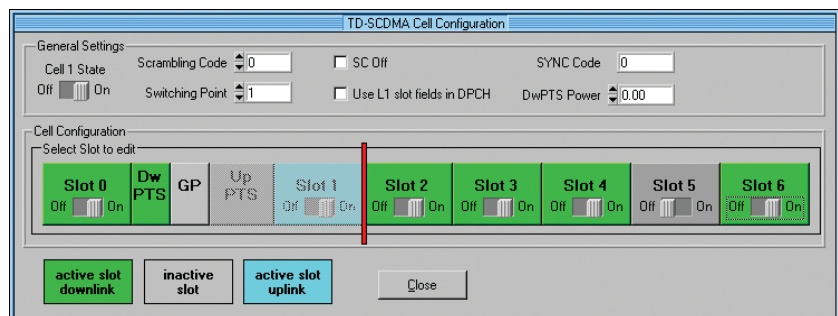

Configuration of TD-SCDMA signal

CCDF of a TDD signal calculated for the complete signal (red) and for an active timeslot (blue)

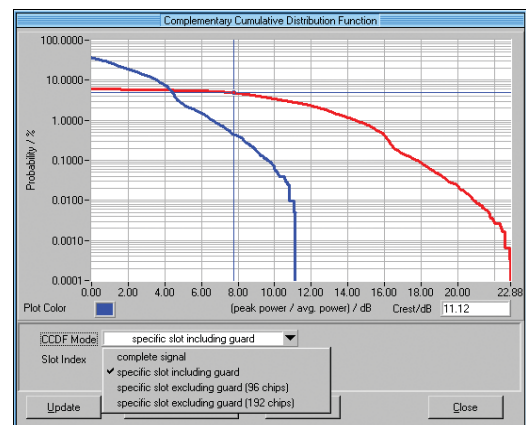

Due to the superposition of many code channels, high power peaks occur in all CDMA and WCDMA signals, which is reflected in a high crest factor. This means that a wide dynamic range is required for the transmission system with

all its components such as power amplifiers. Since extreme signal peaks are relatively rare, as can be seen from the CCDF, clipping of the signal peaks can be performed without essentially degrading the bit error rate. Clipping prior to baseband

filtering does not cause a change in the frequency spectrum of the signal, either.

The clipping level can be set between 1% and 100% relative to the maximum level peak. In the TDD mode of the 3GPP standard, and also with TD-SCDMA, scalar clipping is available in addition to conventional vector clipping.

W-LAN (12a, 12b)

In addition to the comprehensive functionality for the mobile radio standards, R&S WinIQSIM™ also covers the Wireless LAN standards IEEE 802.11b and IEEE 802.11a.

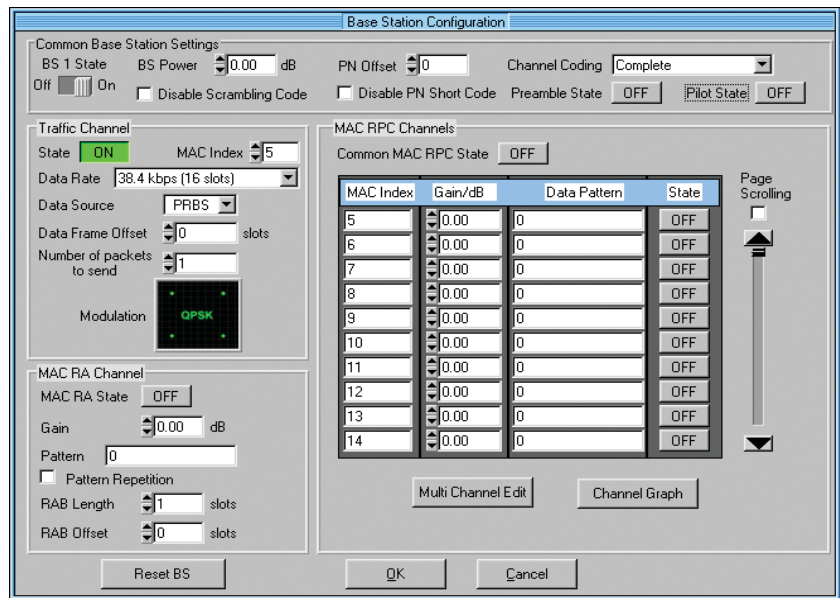

Configuration of a 1xEV-DO base station

The four data rates used by 802.11b (1 Mbps, 2 Mbps, 5.5 Mbps and 11 Mbps) as well as all the possible modulation modes (DBPSK, DQPSK, CCK and PBCC) are fully supported by R&S WinIQSIM™. A direct sequence spread spectrum method is used for radio transmission. Irrespective of the data rate, a chip rate of 11 Mcps is used with this method.

R&S WinIQSIM™ is also capable of generating signals to IEEE 802.11a. It supports all bit rates (6 Mbps to 54 Mbps) defined by this standard as well as the specified modulation mode (OFDM) including coding.

Effect of clipping on the constellation diagram with vectorial (bottom right) and scalar (bottom left) clipping with clipping level of 50% in each case

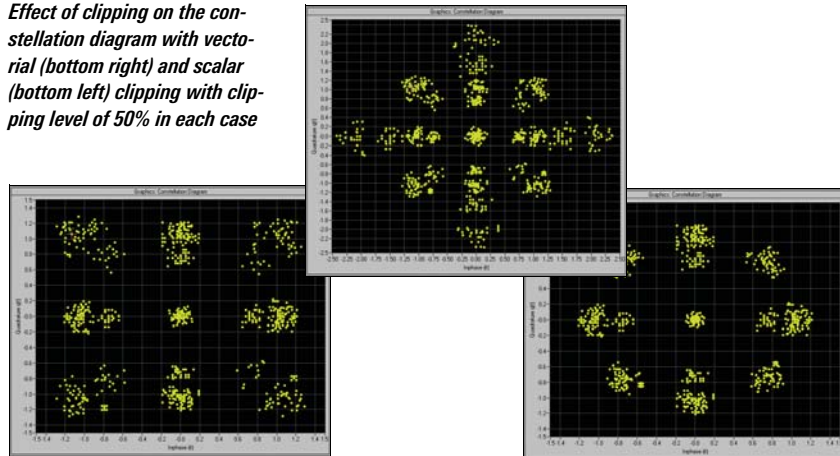

Since data is transferred in packets with IEEE 802.11b and IEEE 802.11a, R&S WinIQSIM™ enables the number of packets, the packet length and the idle time between the packets to be entered. For test purposes, R&S WinIQSIM™ can additionally simulate a continuous data stream without packet structure (unframed mode).

Other OFDM standards (e.g. HIPERLAN/2) are covered by the additional software program R&S WinIQOFDM*).

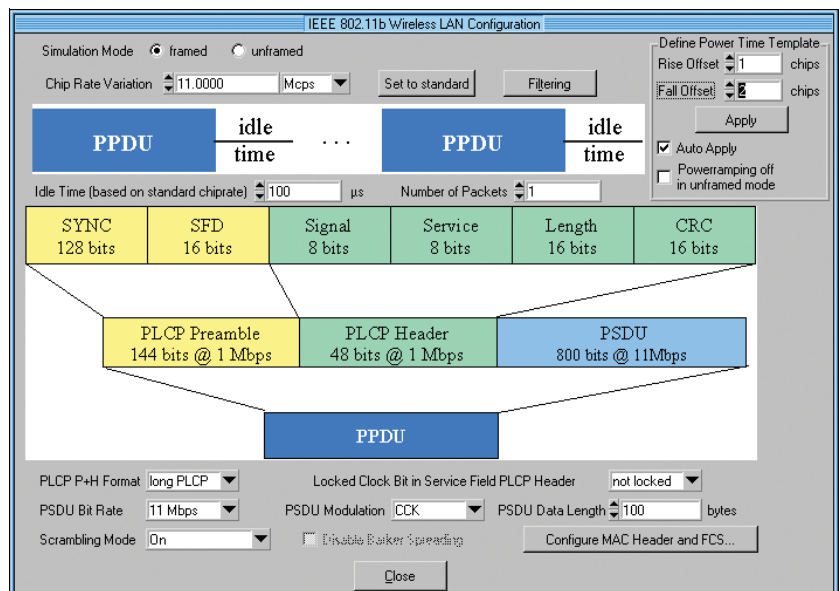

*) Available at www.rohde-schwarz.com

Operating menu for Wireless LAN standard IEEE 802.11b

Data editor (13, 14)

Another special feature of R&S WinIQSIM™ is the data editor for convenient generation of TDMA frame structures, which is especially designed for the single-carrier mode. R&S WinIQSIM™ already provides preconfigured files for the main TDMA standards such as GSM, GSM/EDGE, DECT, PDC and NADC. A choice of different burst types with the associated data structure is available for the individual systems. Frame and time-slot configuration conform to the relevant standard. Basic configurations can easily be modified, stored and used again in subsequent tests.

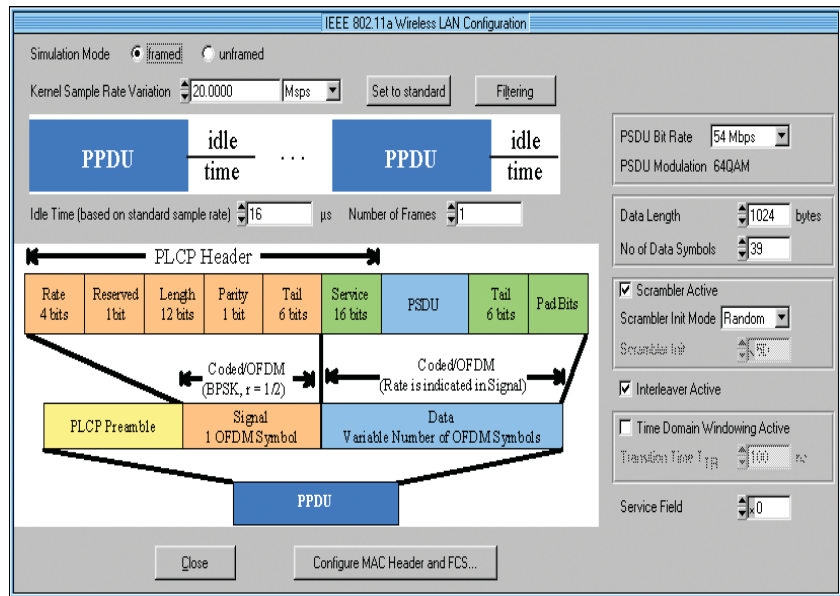

12b

Operating menu for Wireless LAN standard IEEE 802.11a

The data editor provides users involved in defining or developing new TDMA standards with an almost infinite number of possibilities. The structure of a TDMA signal with its basic elements (data fields of a burst) can be completely defined and successively configured into bursts and frames. In this way, it is possible to design an individual standard. In addition to the graphical representation of the data structures, power ramping can also be defined at the data level.

Main menu of data editor

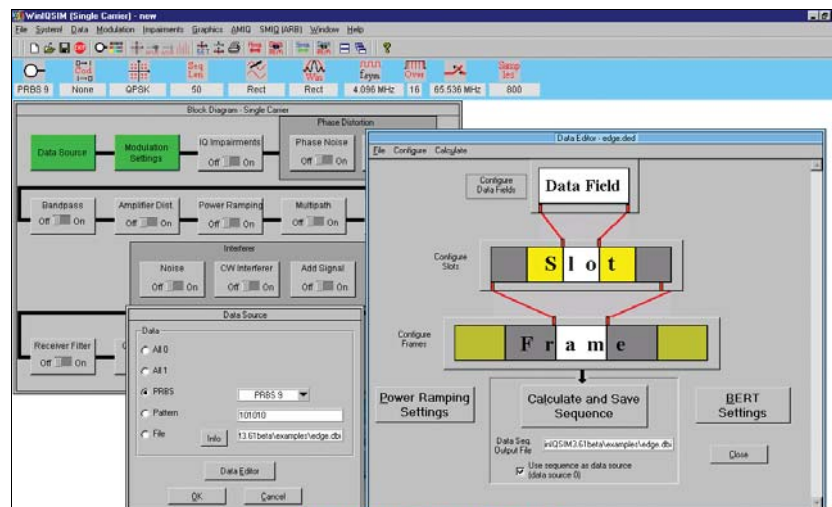

13

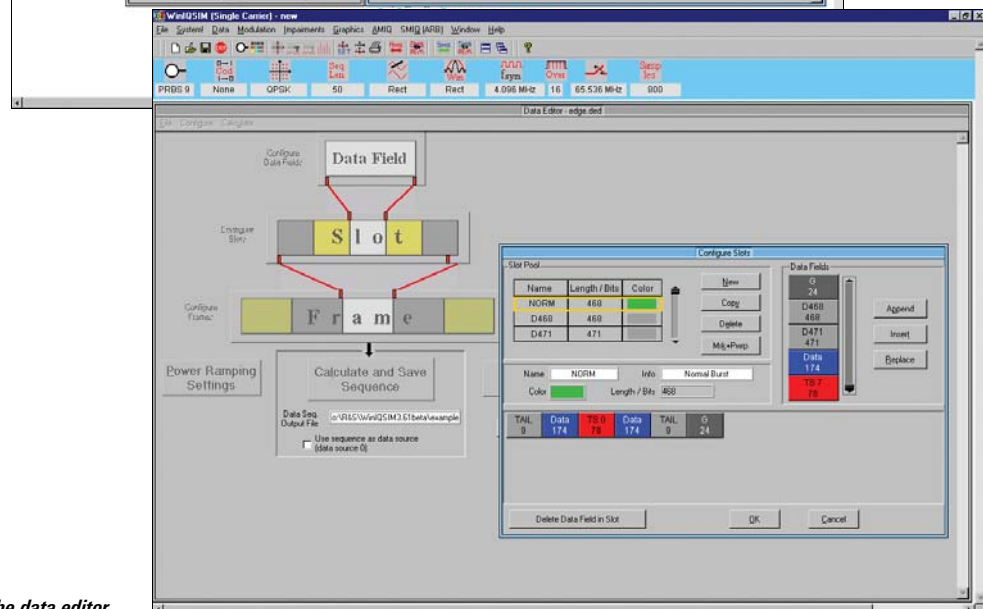

14

Definition of slots in the data editor

Multicarrier signals (15, 16)

In addition to single-carrier signals, multicarrier signals with all their characteristic parameters such as number of carriers (up to 512), carrier spacing, modulation (same for all carriers) and carrier power can be simulated. In this way, composite signals consisting of modulated and unmodulated carriers or signals with several superimposed impairments can be generated. What makes this application so attractive is that only one generator is needed to produce these signals, which means an enormous cost benefit.

Another operating mode (multicarrier mixed signal mode) allows up to 32 differently modulated carriers to be combined with any signal from various systems (single-carrier, multicarrier, WCDMA 3GPP FDD and TDD, TDSCDMA, CDMA2000, IS-95) at variable power levels. Signal scenarios such as several different WCDMA carriers can thus be simultaneously simulated and generated by the R&S AMIQ or R&S SMIQB60.

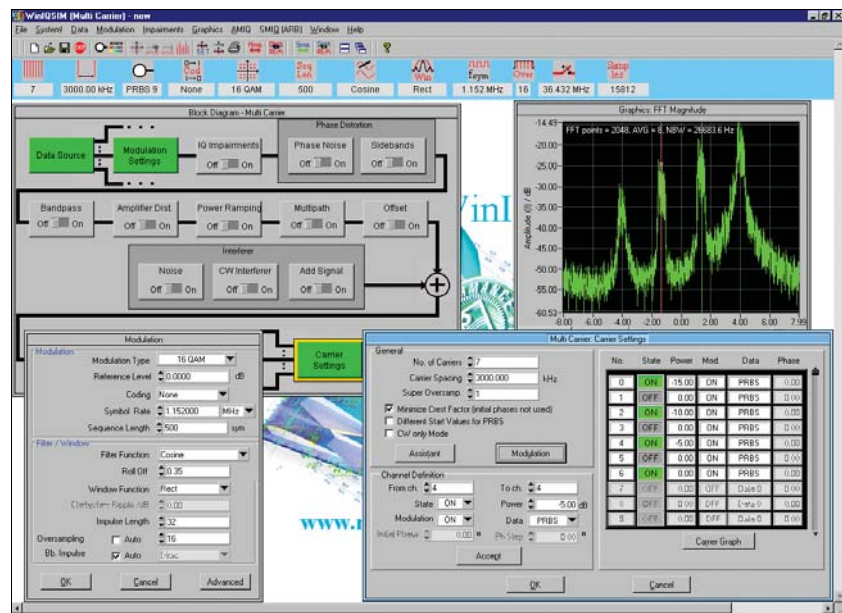

Generation of a multicarrier signal

Generation of a multicarrier signal comprising two WCDMA 3GPP FDD signals, one TDD signal and one TD-SCDMA signal

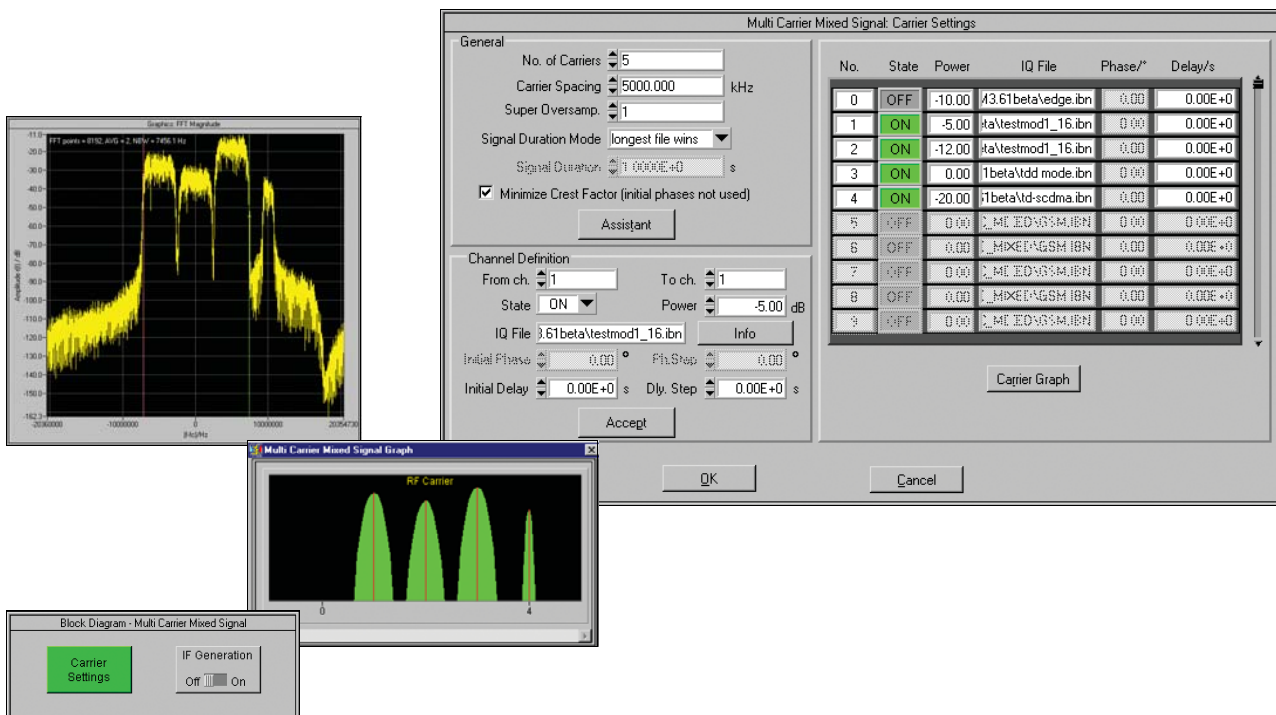

Import system (17)

Data from other PC programs can be read in via the import system. The TCP/IP or the dynamic data exchange (DDE) interface serves as the software interface.

Data can, for example, be imported from the R&S WinIQOFDM software, which is used for generating OFDM-modulated signals. Through subsequent processing in R&S WinIQSIM™, signal modifications such as baseband filtering and superimposed impairments can be applied to the signal to be generated.

The import interface also forms the basis for further applications (e.g. R&S IQWizard, for more information see www.rohde-schwarz.com) or customer-specific enhancements.

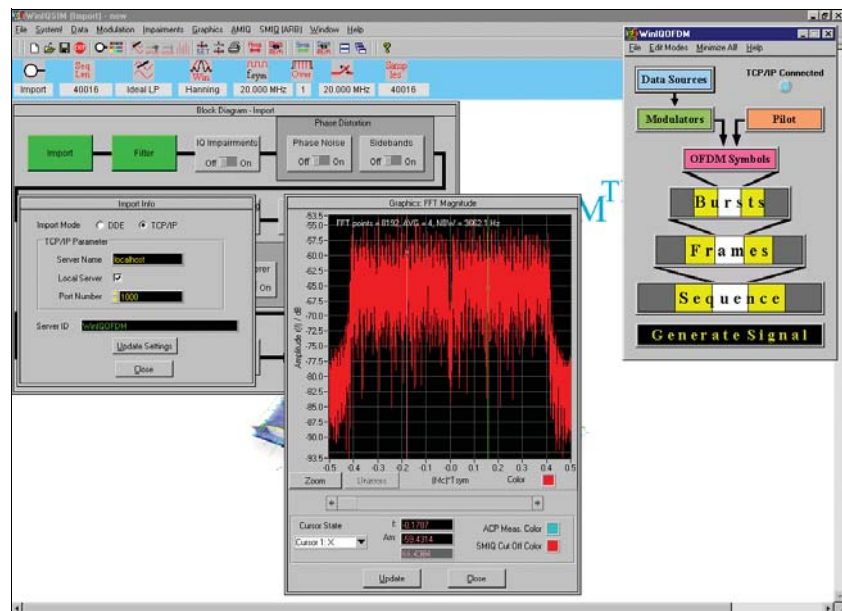

17

Functioning of the import system with R&S WinIQOFDM software

Remote-control functions (18)

The R&S WinIQSIM™ PC program is used to control and operate the I/Q Modulation Generators R&S AMIQ and the SMIQ-integrated solution R&S SMIQB60.

For the R&S AMIQ, it provides file management on the internal hard disk, and controls the hardware settings and all other functions.

The functionality of R&S WinIQSIM™ regarding device control is especially important in bit error rate measurements with the R&S AMIQ (option R&S AMIQ-B1). In addition to performing the control functions, the software outputs the measurement results in an R&S WinIQSIM™ window.

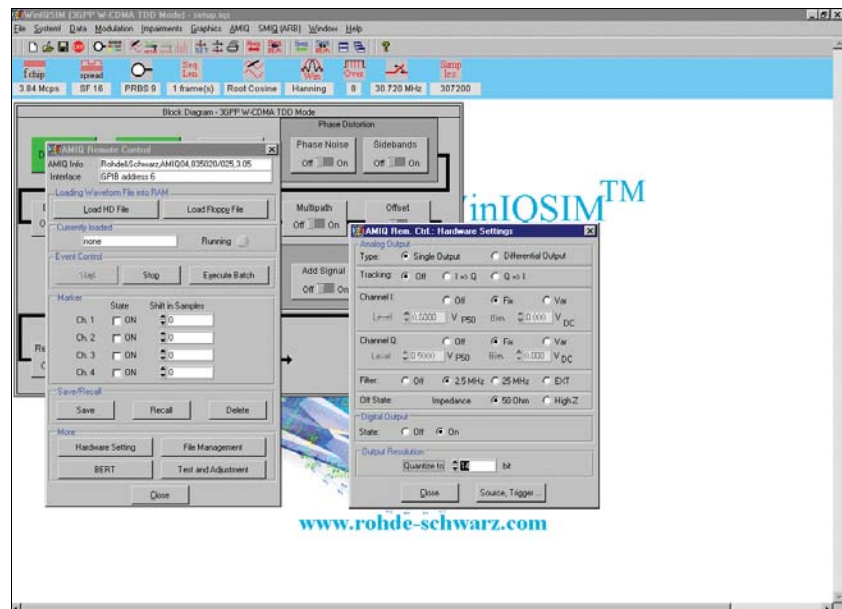

18

User interface for controlling the R&S AMIQ with R&S WinIQSIM™

Specifications

User interface	Windows interface with context-sensitive help
Systems	single-carrier, multicarrier, multicarrier mixed signal, WCDMA 3GPP FDD, WCDMA 3GPP TDD, TD-SCDMA, IS-95, CDMA2000

Single carrier

Simulation of digitally modulated single-carrier signals incl. TDMA	
Modulation modes	
PSK	BPSK, QPSK, offset QPSK, $\pi/4$ DQPSK, 8PSK, 8PSK EDGE;
Parameter	reference level = -10 dB to 3 dB PSK rotation = 0 to $15 \times \pi/8$
QAM	16/32/64/256QAM
Parameter	reference level = -10 dB to 3 dB
FSK	MSK, 2FSK, 4FSK, GTFM
Parameter	modulation index = 0.1 to 12 GTFM b = 0 to 1
User-specific modulation	definition of customized modulation modes (PSK, QAM, FSK) via data interface with up to 4.096 mapping states
Baseband filters	Fourier approximation design method with windowing
Digital filters	rectangular $\sqrt{\text{cosine}}$, $\alpha = 0.01$ to 0.99 cosine, $\alpha = 0.01$ to 0.99 Gaussian, BxT = 0.1 to 3.0 Gaussian EDGE partial response no filter
User-specific filter	customized filter defined via file interface, specification of impulse response in time domain with up to 1024 coefficients, different filter coefficients for I and Q channel possible
Window	rectangular Hanning Kaiser, $\beta = 0.01$ to 10.0 Hamming Chebyshev, ripple = 10 dB to 80 dB
Window length	1 to 32 (integer)
Oversampling	1 to 32 (integer)
Symbol rate	10 symb/s to max. 100 Msymb/s
Coding	Gray, Diff, Gray Diff, GSM Diff, NADC, TFS, MSAT Diff, Phase Diff, none
Data sources	all 0, all 1, PRBS (7, 9, 11, 15, 16, 20, 21, 23), pattern (max. 79 bit), user-defined data sequence via file interface
Data editor	definition of TDMA data structures with modularity at three levels: data field, slot and frame, definition of power-time templates
Data fields	up to 50 different fields, length up to 1000 bit, data content: all 0, all 1, pattern (max. 79 bit) or PRBS
Slots	up to 24 different slots, any combination of up to 36 data fields
Frame	any combination of up to 36 slots
Sequence length	1 to max. 4 (16) Msample (R&S AMIQ03/R&S AMIQ04)
Simulation of impairments and transfer characteristics	
I/Q impairment	carrier leakage I and Q (-50% to +50%) I/Q imbalance (-30% to +30%) quadrature offset (-30° to +30°) AM/AM conversion (k2; k3 -3 to +3 dB) AM/ ϕ M conversion (k2; k3 -30° to +30°)

Phase noise	simulation of impairments of phase-locked loop (VCO) and discrete spurious lines
Bandpass	simulation of bandpass at the RF with amplitude and group delay distortion
Amplifier models	amplifiers with soft and hard limiting, nonlinearities: AM/AM k3, k5 -3 dB to +3 dB; AM/ ϕ M k3, k5 -30° to +30°
Power ramping	ramp function: linear, \cos^2 rise/fall time: 0 to 16 T _{sym} level: -80 dB to 0 dB
Multipath propagation	up to 6 paths with different delays, start phases and levels
Offset	phase offset: -180° to +180° frequency offset: $-0.35 f_{\text{sample}}$ to $+0.35 f_{\text{sample}}$
Additive impairments	
Noise	$E_b/N_0 = -3$ dB to +80 dB, bandwidth 0.5/1/2/4/8/16 f_{symbol}
Sinewave interferer	C/I = -3 dB to +80 dB, frequency $-0.35 f_{\text{sample}}$ to $+0.35 f_{\text{sample}}$
Superimposed signal	addition of a previously calculated signal, level -80 dB to +3 dB
Receiver filters	rectangular $\sqrt{\text{cosine}}$, $\alpha = 0.01$ to 0.99 Gaussian, BxT = 0.1 to 3.0 user-specific (see above)
Quantization	I/Q resolution: 1×10^{-6} to 0.5; filter coefficient resolution: 10^{-6} to 0.5
Smoothing	smoothing the wraparound of the I/Q signal between signal end and signal start: in range 2 sample to 32 sample
Graphical output	user-selectable scaling, zoom function, delta marker; display modes: i(t), q(t), r(t), phi(t), r(t), f(t), eye I, eye Q, eye F, vector diagram, constellation diagram, magnitude/phase/group-delay spectrum, additionally CCDF and ACP (see below)
CCDF function	determination and graphical display of complementary cumulative distribution function with calculation of crest factor
ACP calculation	calculation of adjacent-channel power in the spectrum display (ACP up, low and ACP up 1st alt, low 1st alt)
IF signal generation	modulation of calculated I/Q signal to IF in range 0.01 MHz to 25 MHz (output to I channel of R&S AMIQ)

Multicarrier

Simulation of multicarrier signals with same or without modulation	
Number of carriers	max. 512 carriers
Parameters of each carrier	state on/off, power, modulation on/off, data source, start phase
Modulation modes	same as with single-carrier system, each carrier can be modulated or not, modulated carriers use the same modulation mode
Baseband filtering	same as with single-carrier system, identical for all modulated carriers
Coding	same as with single-carrier system, identical for all modulated carriers
Data sources	4 different sources, 3 same as in single-carrier system, another PRBS source with different start values for different carriers
Data editor	same as with single-carrier system
Carrier power	-80 dB to 0 dB
Start phase of carrier CW signal	0° to 360° selectable for each carrier or automatic setting for minimizing the crest factor

Sequence length	1 to max. 4 (16) Msample (R&S AMIQ03/R&S AMIQ04)
Simulation of impairments and transfer characteristics	same as with single-carrier system, identical for all modulated carriers
Smoothing	same as with single-carrier system
Graphical output	same as with single-carrier system
CDF function	same as with single-carrier system
ACP calculation	same as with single-carrier system
IF signal generation	same as with single-carrier system

Multicarrier mixed signal

Simulation of differently modulated multicarrier signals and signals of different systems on the carriers

Number of carriers	max. 32
Parameters of each carrier	state on/off, power, I/Q modulation file, start phase
I/Q modulation signal	an I/Q signal file onto which the carrier is to be modulated can be defined for each carrier; these signal files can be generated in all systems
Carrier power	-80 dB to 0 dB
Start phase of carrier CW signal	0° to 360° selectable for each carrier or automatic setting for minimizing the crest factor
Signal period	automatically adapted to longest or shortest carrier signal period or user-selectable (max. duration 4 Msample (16 Msample)/sample rate, R&S AMIQ03/R&S AMIQ04)
Graphical output	same as with single-carrier system
CCDF function	same as with single-carrier system
ACP calculation	same as with single-carrier system
IF signal generation	same as with single-carrier system

WCDMA 3GPP FDD

Version 4.1.0 to 3GPP Technical Specifications TS25.211, TS25.213, TS25.141, TS25.101 and TS25.104

General settings

Chip rate	
Standard	3.840 Mcps (15 slots/frame)
Range	10 cps to 100 Mcps
Link direction	uplink (reverse link) and downlink (forward link)
Sequence length	1 to 26 frames R&S AMIQ03 (oversampling 4) 1 to 104 frames R&S AMIQ04 (oversampling 4) 1 to 6 frames R&S SMIQB60 (oversampling 2)
Baseband filter	
Standard	$\sqrt{\cos}$, $\alpha = 0.22$
Other filters	same as with single-carrier system
Clipping level	setting of clipping value relative to highest peak in percent; clipping takes place prior to baseband filtering and reduces the crest factor; range 1% to 100 %
Code channels	
Downlink	up to 512 data channels (plus special channels) divided among up to four base stations (BS) with 128 code channels each
Uplink	up to four mobile stations (MS) each operating in one of modes PRACH only, PCPCH only, DPCCCH + DPDCCHs

Physical channels in downlink

P-CPICH	Primary Common Pilot Channel
Symbol rate	15 ksps, fixed
Channelization code	0, fixed
Slot structure	predefined symbols
S-CPICH	Secondary Common Pilot Channel
Symbol rate	15 ksps, fixed
Channelization code	0 to 255
Slot structure	predefined symbols
P-SCH	Primary Sync Channel
Symbol rate	15 ksps, fixed
Slot structure	synchronization code (SC)
S-SCH	Secondary Sync Channel
Symbol rate	15 ksps, fixed
Slot structure	synchronization code (SC)
P-CCPCH	Primary Common Control Physical Channel
Symbol rate	15 ksps, fixed
Channelization code	1, fixed
Slot structure	data
S-CCPCH	Secondary Common Control Physical Channel
Symbol rate	15, 30, 60, 120, 240, 480, 960 ksps depending on symbol rate, 0 to max. 255
Channelization code	data, TFCI, pilot
Slot structure	
PICH	Page Indication Channel
Symbol rate	15 ksps, fixed
Channelization code	0 to 255
Number of PIs per frame	18, 36, 72, 144
Slot structure	page indicator bits, not used bits
AP-AICH	Access Preamble Acquisition Indication Channel
Symbol rate	15 ksps, fixed
Channelization code	0 to 255
Slot structure	acquisition indicators, empty symbols
AICH	Acquisition Indication Channel
Symbol rate	15 ksps, fixed
Channelization code	0 to 255
Slot structure	acquisition indicators, empty symbols
PDSCH	Physical Downlink Shared Channel
Symbol rate	15, 30, 60, 120, 240, 480, 960 ksps depending on symbol rate, 0 to max. 255
Channelization code	data
Slot structure	
DL-DPCCH	Dedicated Physical Control Channel
Symbol rate	7.5 ksps, fixed
Channelization code	0 to 511
Slot structure	TPC, pilot
DPCH	Dedicated Physical Channel
Symbol rate	7.5, 15, 30, 60, 120, 240, 480, 960 ksps depending on symbol rate
Channelization code	0 to max. 511
Slot structure	data 1, TPC, TFCI, data 2, pilot
Physical channels in uplink	
PRACH	Physical Random Access Channel
Symbol rate	15, 30, 60, 120 ksps
Frame structure	preamble(s), message part consisting of data and control section
Preamble part power	-60 dB to 0 dB
Data part power	-60 dB to 0 dB
Control part power	-60 dB to 0 dB
Preamble repetition	1 to 10
Signature	0 to 15
Access slot	0 to 14
Message part length	1 or 2 frames
TFCI	0 to 1023
User data	PRBS: PN9, PN11, PN15, PN16 all 0, all 1 and bit pattern (max. length 16 bit)

PCPCH	Physical Common Packet Channel
Symbol rate	15, 30, 60, 120 ksps
Frame structure	access preamble(s), collision detection preamble, power control preamble, message part consisting of data and control section
Preamble part power	-60 dB to 0 dB
Data part power	-60 dB to 0 dB
Control part power	-60 dB to 0 dB
Preamble power step	0 dB to 10 dB
Shared resource mode	ON/OFF
Preamble repetition	1 to 10
Signature	0 to 15
Access slot	0 to 14
Message part length	1 to 10 frames
Power control preamble length	0 or 8 slots
FBI state	OFF/1 bit/2 bit
FBI pattern	all 0, all 1 and bit pattern (max. length 16 bit)
User data	PRBS: PN9, PN11, PN15, PN16 all 0, all 1 and bit pattern (max. length 16 bit)
DPCCCH	Dedicated Physical Control Channel
Symbol rate	15 ksps, fixed
Channelization code	0, fixed
DL-UL timing offset	1024 chips, fixed
FBI state	OFF/1 bit/2 bit
FBI pattern	all 0, all 1 and bit pattern (max. length 16 bit)
TFCI state	ON/OFF
TFCI	0 to 1023
Use TPC for dynamic output power control	ON/OFF If this function is active, the TPC pattern is used to vary the transmit power of the MS code channels versus time.
Output power control step	-10 dB to +10 dB
DPDCH	Dedicated Physical Data Channel
Overall symbol rate	overall data rate of all uplink DPDCHs 15, 30, 60, 120, 240, 480, 960, 2 x 960, 3 x 960, 4 x 960, 5 x 960, 6 x 960 ksps
Active DPDCHs	1 to 6, depending on overall symbol rate
Symbol rate	fixed for active DPDCHs, depending on overall symbol rate
Channelization code	fixed for active DPDCHs, depending on overall symbol rate
Channel power	-60 dB to 0 dB for all DPDCHs
User data	PRBS: PN9, PN11, PN15, PN16 all 0, all 1 and bit pattern (max. length 16 bit)
Parameters for each base station (BS)	
State	ON/OFF
2nd search code group	0 to 63 (depending on scrambling code)
Scrambling code	0 to 5FFF hex or off
TFCI state	ON/OFF
TFCI	0 to 1023
TPC pattern readout mode	use of TPC pattern: continuous, single + all 0, single + all 1, single + alternating 01, single + alternating 10
Use TPC for dynamic output power control	ON/OFF If this function is active, the TPC pattern is used to vary the transmit power of the code channels versus time.
Output power control step	-10 dB to +10 dB
Transmit diversity	OFF/antenna 1/antenna 2 If this function is active, the output signal for antenna 1 or antenna 2 can be generated as defined in the standard.

Parameters for each mobile station (MS)	
State	ON/OFF
Mode	PRACH only, PCPCH only, DPCCCH + DPDCHs
Scrambling code	0 to FF FFFF hex
Scrambling code mode	long, short, off
TPC pattern	all 0, all 1 and bit pattern (max. length 16 bit)
TPC pattern readout mode	use of TPC pattern: continuous, single + all 0, single + all 1, single + alternating 01, single + alternating 10
Parameters independently selectable for each downlink code channel	
State	ON/OFF
Symbol rate	7.5 ksps to 960 ksps, depending on type of physical channel
Channelization code	0 to max. 511, depending on symbol rate and type of physical channel
Power	-60 dB to 0 dB
User data	PRBS: PN9, PN11, PN15, PN16 all 0, all 1 and bit pattern (max. length 16 bit)
Timing offset	separately adjustable for each code channel 0 to 149 (in units of 256 chips)
Pilot length	2, 4, 8, 16 bit, depending on symbol rate
TPC pattern	all 0, all 1 and bit pattern (max. length 16 bit)
Multicode state	ON/OFF
Compressed mode	
State	ON/OFF
Compressed mode method	higher layer scheduling, puncturing (downlink only) or SF/2
Downlink frame structure	type A (last pilot) or type B (first TPC, last pilot)
Power offset for compressed slots	automatic or manual in range 0 dB to 10 dB
Number of transmission patterns	1 or 2
Number of transmission gaps per pattern	2
TGSN (transmission gap slot number)	user-selectable within the range permitted by the standard; conflicting parameters are displayed and solutions proposed
TGL1, TGL2 (transmission gap length 1, 2)	
TGD1, TGD2 (transmission gap distance 1, 2)	
TGPL1, TGPL2 (transmission gap pattern length 1, 2)	
Assistant functions to facilitate operation	
Test models (supplied as example files)	test model 1 with 16/32/64 channels test model 2 test model 3 with 16/32 channels test model 4
Parameterizable predefined settings	Generation of complex signal scenarios in downlink with parameterizable default settings. Selectable parameters: use and symbol rate of special channels (for synchronization of mobile station), number and symbol rate of data channels, crest factor: minimal/average/worst
Multichannel edit	Common configuration of data channels of BS channel table. Selectable parameters, partly with start value and step size: range of data channels to be set, symbol rate, channelization code with step size, channel power with step size, data, TPC, timing offset with step size, multicode state, state

Copy BS/MS	Adopting the configuration of a BS for another BS/MS to define multi-BS/MS scenarios or BS signals with more than 128 channels. Parameters: source and destination of copying, channelization code offset for simple definition of BS signals with more than 128 channels and continuous channelization codes
Resolve domain conflicts	Elimination of code channel overlapping in code domain (domain conflicts) occurring in a BS/MS
Graphical displays	
Domain conflicts	Display of domain conflicts (overlapping of code channels in code domain) in the channel table lines concerned. The code domain occupied by the code channels involved in the conflict can also be displayed.
Code domain	Display of code domain occupied by current BS. Domain areas in which conflicts occur are highlighted. The distribution of code channels in the code domain as well as the channel powers are shown qualitatively.
Channel graph	Display of all active channels of a BS versus the channel table index. The powers of the code channels are shown qualitatively.
CCDF	Display of complementary cumulative distribution function of current signal. This function gives the probability of the magnitudes of complex I/Q samples exceeding a predefined threshold. Together with the current CCDF, the CCDFs of the two 3GPP signals last generated can be displayed to observe the effect of parameter changes. The crest factor of the signal can be seen in the CCDF.
Constellation diagram	Display of constellation diagram versus I/Q samples of current 3GPP signal. This diagram allows qualitative assessment of channel configuration, channel power ratios, and effect of parameters such as data and data offset.

WCDMA 3GPP TDD (with option R&S AMIQ13/R&S SMIQ13)

Simulation of signals to time division duplex wideband CDMA standard according to version 4.1.0 of the 3GPP Technical Specification TS 25.221, TS 25.223, available as Software Option R&S AMIQ13 of the R&S AMIQ or Software Option R&S SMIQ13 and Arbitrary Waveform Generator Option R&S SMIQB60 of the R&S SMIQ

General settings

Chip rate	3.84 Mcps
Standard	R&S AMIQ:
Range	10 cps to max. 100 Mcps R&S SMIQ (B60): 1 kcps to max. 40 Mcps
Mode	downlink only: the base station components of a cell are active uplink only: the mobile station components of a cell are active downlink and uplink: both the base station and the mobile station components of a cell are active

Sequence length	entry in slots (0.667 ms each) or frames (10 ms each), max. length depending on oversampling R&S AMIQ03 (for oversampling 4): 1 to 26 frames R&S AMIQ04 (for oversampling 4): 1 to 104 frames R&S SMIQB60 (for oversampling 2 in R&S WinIQSIM™ (oversampling >4 as a result of hardware oversampling in the R&S SMIQ)): 1 to 6 frames
Baseband filter	Standard Other filters
	root raised cosine filter, roll off = 0.22 same as with single-carrier system
Cells	simulation of up to 4 cells, each comprising 15 slots
Clipping level	Setting of clipping value relative to highest peak in percent. Clipping takes place prior to baseband filtering. Either scalar mode or vector mode can be selected. Clipping reduces the crest factor. The range is 1% to 100%.
Parameters for each cell	
State	ON/OFF
Frame structure	The link direction (uplink or downlink) can be set independently for each of the 15 slots of the frame. All single- and multi-switching point configurations can be simulated.
Scrambling code	0 to 127 scrambling code can be disabled for testing
Code group	automatic selection depending on scrambling code 0 to 31
Midamble allocation method	default common equal to scrambling code
Guard field power state	OFF (according to standard)/ON
Parameters for each downlink slot	
State	ON/OFF
Slot mode	downlink dedicated: simulation of up to 16 DPCHs and max. 6 special channels
Burst type	1 and 2
SCH assoc. t_offset	automatic selection depending on scrambling code 0 to 31
SCH code allocation	cases 1 and 2 to TS 25.223
Page indicator length	2, 4, 8
Parameters for each uplink slot	
Slot mode	uplink dedicated: simulation of up to 16 DPCHs and 1 special channel PRACH: simulation of one Physical Random Access Channel
TPC pattern readout mode	application mode for TPC pattern continuous, single + all 0, single + all 1, single + alt. 01, single + alt. 10
Burst type	1, 2 and 3
Parameters in uplink PRACH mode	
Burst type	3
Start frame	selection of first frame in which PRACH is sent 0 to 10
PRACH length	length of PRACH message part 1 to 10 frames
User	index of user to which PRACH is assigned
Midamble and midamble shift	display of midamble used and of midamble time shift, depending on midamble allocation method and user
Spreading factor	8 and 16

Spreading code	spreading code of channel, range depending on spreading factor 1 to max. 16
Power	-60 dB to 0 dB
Physical channels	
Data	4 different data sources, 3 same as with single-carrier system, another PBRS source with differing start values for different code channels
Downlink	Primary Common Control Physical Channel (P-CCPCH) Secondary Common Control Physical Channel (S-CCPCH) Primary Sync Channel (P-SCH) Secondary Sync Channel (S-SCH) Physical Downlink Shared Channel (PDSCH) Page Indicator Channel (PICH) Dedicated Physical Channel (DPCH)
Uplink	Physical Random Access Channel (PRACH) Physical Uplink Shared Channel (PUSCH) Dedicated Physical Channel (DPCH)
Parameters independently selectable for each code channel	
State	ON/OFF
User	1 to 16 with burst types 1 and 3 1 to 6 with burst type 2
Spreading factor	depending on channel type and link direction 1, 2, 4, 8, 16
Spreading code	depending on channel type and spreading factor 1 to max. 16
Midamble and midamble shift	display of midamble used and of midamble time shift, depending on midamble allocation method and user
TFCI/TPC combination	combination of TFCI and TPC fields, TPC in uplink only, uplink: TFCI 0 TPC 0, TFCI 0 TPC 2, TFCI 4 TPC 2, TFCI 8 TPC 2, TFCI 16 TPC 2, TFCI 32 TPC 2 downlink: TFCI 0, TFCI 4, TFCI 8, TFCI 16, TFCI 32
TFCI	transport format combination indicator 0 to 1023
TPC pattern	bit pattern (max. length 16 bit) as a data source for the TPC field of the channel, in uplink only
Power	-60 dB to 0 dB
Data	4 different data sources, 3 same as single-carrier system, another PBRS source with differing start values for different code channels
Assistant functions to facilitate operation	
Copy cell	Adopting the configuration of a cell for another cell to define multicell scenarios. Parameters: source and destination of copying
Resolve domain conflicts	Elimination of code channel overlapping in code domain occurring in a slot (domain conflicts).
Graphical displays	
Domain conflicts	Display of domain conflicts (overlapping of code channels in code domain) in the channel table lines concerned. The code domain occupied by the code channels involved in the conflict can also be displayed.
Code domain	Display of code domain occupied by active slot. Domain areas in which conflicts occur are highlighted. Code channel distribution in the code domain and channel powers are displayed.

Channel graph	Display of all active channels of a slot versus the channel table index. The powers of the individual code channels are indicated.
CCDF	Display of complementary cumulative distribution function of current signal. This function gives the probability of the magnitudes of the complex I/Q samples exceeding a predefined threshold. Together with the current CCDF, the CCDFs of any number of 3GPP TDD signals generated last can be displayed to observe the effect of parameter changes. The crest factor of the signal can be seen in the CCDF.
Constellation diagram	Display of constellation diagram versus I/Q samples of current 3GPP TDD signal. This diagram allows qualitative assessment of channel configuration, channel power ratios, and effect of TDD system parameters.

Digital standard TD-SCDMA (with option R&S AMIQK14/R&S SMIQK14)

Simulation of signals according to time division synchronous CDMA standard of China Wireless Telecommunication Standard Group (CWTS), available as Software Option R&S AMIQK14 of the R&S AMIQ or Software Option R&S SMIQK14 and Arbitrary Waveform Generator Option R&S SMIQB60 of the R&S SMIQ

General settings

Chip rate	Standard Range	1.28 Mcps R&S AMIQ: 10 cps to max. 100 Mcps R&S SMIQ (B60): 1 kcps to max. 40 Mcps
Mode		downlink only: the base station components of a cell are active uplink only: the mobile station components of a cell are active downlink and uplink: both the base station and the mobile station components of a cell are active
Sequence length		entry in frames (5 ms each), max. length depending on oversampling and R&S AMIQ03 (for oversampling 4): 1 to 156 frames R&S AMIQ04 (for oversampling 4): 1 to 625 frames R&S SMIQ (B60); (for oversampling 2 in R&S WinIQSIM™ (oversampling >4 as a result of hardware oversampling in the R&S SMIQ)): 1 to 40 frames
Baseband filter	Standard Other filters	root raised cosine filter, roll off = 0.22 same as with single-carrier system
Cells		simulation of up to 4 cells, each comprising 7 traffic slots and 3 special slots
Clipping level		Setting of clipping value relative to highest peak in percent. Clipping takes place prior to baseband filtering. Either scalar mode or vector mode can be selected. Clipping reduces the crest factor. The range is 1% to 100%.

Parameters for each cell	
State	ON/OFF
Frame structure	total of 7 traffic slots, slot 0 always reserved for downlink, slot 1 to switching point reserved for uplink, other slots reserved for downlink; special slots between slots 0 and 1: Downlink Pilot Slot (DwPTS), Guard Period (GP) and Uplink Pilot Slot (UpPTS)
Scrambling code	0 to 127 scrambling code can be disabled for testing
SYNC code	automatic selection depending on scrambling code 0 to 31
Switching point	switchover between uplink and downlink slots 1 to 6
Layer 1 control fields	can be enabled and disabled to simulate burst types 1 and 2
DwPTS power	-60 dB to 0 dB
Parameters for each downlink slot	
State	ON/OFF
Slot mode	downlink dedicated: simulation of up to 16 DPCHs and max. 5 special channels
TPC pattern readout mode	application mode for TPC pattern: continuous, single + hold 01, single + hold 10, single + all up, single + all down
Sync shift repetition mode	number of frames to which sync shift bits are distributed 1 to 500
Stealing flag	value of the two stealing bits 0 to 3
Parameters for each uplink slot	
Slot mode	uplink dedicated: simulation of up to 16 DPCHs PRACH: simulation of one Physical Random Access Channel
TPC pattern readout mode	application mode for TPC pattern: continuous, single + hold 01, single + hold 10, single + all up, single + all down
Sync shift repetition mode	number of frames to which sync shift bits are distributed 1 to 500
Stealing flag	value of the two stealing bits 0 to 3
Parameters in uplink PRACH mode	
SYNC 1	SYNC 1 code 0 to 7
UpPTS start frame	selection of first frame in which UpPTS is sent 1 to 6
UpPTS repetition	number of UpPTS repetitions 1 to 10
PRACH length	length of PRACH message part 1 to 10 frames
Gross data rate	17.6 kbps, 35.2 kbps
Spreading code	depending on gross data rate 0 to max. 15
Sync shift pattern	bit pattern (max. length 16 bit) as a data source for the sync shift field of the channel
TPC pattern	bit pattern (max. length 16 bit) as a data source for the TPC field of the channel
Power	-60 dB to 0 dB
Data	4 different data sources, 3 same as with single-carrier system, another PRBS source with differing start values for different code channels

Physical channels	
Downlink	Primary Common Control Physical Channel (P-CCPCH) Secondary Common Control Physical Channel (S-CCPCH) Physical Forward Access Channel (F-FACH) Downlink Pilot Time Slot (DwPTS) Dedicated Physical Channel (DPCH)
Uplink	Physical Random Access Channel (PRACH) Uplink Pilot Time Slot (UpPTS) Dedicated Physical Channel (DPCH)
Parameters independently selectable for each channel	
State	ON/OFF
Gross data rate	depending on channel type 17.6 kbps, 35.2 kbps, 70.4 kbps, 140.8 kbps, 281.6 kbps (spreading factors 1, 2, 4, 8, 16)
Spreading code	depending on channel type and gross data rate 0 to max. 15
Midamble shift	time shift of midamble in chips: 0 to 120, step width 8 chips
Power	-60 dB to 0 dB
Data	4 different data sources, 3 same as with single-carrier system, another PRBS source with differing start values for different code channels
Sync shift pattern	bit pattern (max. length 16 bit) as a data source for the sync shift field of the channel
TPC pattern	bit pattern (max. length 16 bit) as a data source for the TPC field of the channel
Assistant functions to facilitate operation	
Predefined settings	Generation of complex signal scenarios with parameterizable default settings. Selectable parameters: use of special channels (P-CCPCH), number and gross data rate of data channels, crest factor: minimal/average/worst
Copy cell	Adopting the configuration of a cell for another cell to define multicell scenarios. Parameters: source and destination of copying
Resolve domain conflicts	Elimination of code channel overlapping in code domain occurring in a slot (domain conflicts).
Graphical displays	
Domain conflicts	Display of domain conflicts (overlapping of code channels in code domain) in the channel table lines concerned. The code domain occupied by the code channels involved in the conflict can also be displayed.
Code domain	Graphical Display of code domain occupied by active slot. Domain areas in which conflicts occur are highlighted. Code channel distribution in the code domain and channel powers are displayed.
Channel graph	Display of all active channels of a slot versus the channel table index. The powers of the individual code channels are indicated.

CCDF	Display of complementary cumulative distribution function of current signal. This function gives the probability of the magnitudes of the complex I/Q samples exceeding a predefined threshold. Together with the current CCDF, the CCDFs of any number of TD-SCDMA signals generated last can be displayed to observe the effect of parameter changes. The crest factor of the signal can be seen in the CCDF.
Constellation diagram	Display of constellation diagram versus I/Q samples of current TD-SCDMA signal. This diagram allows qualitative assessment of channel configuration, channel power ratios, and effect of TD-SCDMA system parameters.

Digital standard IS-95 (with option R&S AMIQ11/R&S SMIQ11)

Simulation of CDMA signals to North American standard IS-95 A, available as Software Option R&S AMIQ11 of the R&S AMIQ or Software Option R&S SMIQ11 in conjunction with the Arbitrary Waveform Generator Option R&S SMIQB60 of the R&S SMIQ

General settings

Chip rate	
Standard	1.2288 Mcps
Range	R&S AMIQ: 10 cps to 100 Mcps R&S SMIQB60: 1 kcps to 40 Mcps
Link direction	forward link and reverse link
Sequence length	entry in symbols (1536 symbols correspond to 80 ms frame), max. length depending on oversampling R&S AMIQ03 (for oversampling 4): 1 to 10 frames R&S AMIQ04 (for oversampling 4): 1 to 40 frames R&S SMIQB60 (for oversampling 2 in R&S WinIQSIM™, and oversampling >4 as a result of hardware oversampling in the R&S SMIQ): 1 to 2 frames
Baseband filter	
Standard	CDMA2000 1X (corresponds to IS-95 filter)
Other filters	same as with single-carrier system
Clipping level	Setting of clipping value relative to highest peak in percent. Clipping takes place prior to baseband filtering and reduces the crest factor. The range is 1% to 100%.
Parameters for each base station	PN offset 0 to 511
Parameters for each code channel	state on/off, power, data, long code mask
Physical channels in forward link	
Pilot	
Paging	parameters: data, long code mask with PCN and pilot PN field
Sync	parameter: data
Traffic	parameters: data, long code mask with permuted ESN field
Physical channels in reverse link	
Access	parameters: data, long code mask with ACN, PCN, base ID and pilot PN field
Traffic	parameters: data, long code mask with permuted ESN field
Channel power	-40 dB to 0 dB
Modulation data	4 different data sources, 3 same as with single-carrier system, another PRBS source with differing start values for different code channels
Baseband filtering	same as with single-carrier system
Simulation of impairments and transmission characteristics	same as with single-carrier system

Smoothing	same as with single-carrier system
Graphical output	same as with single-carrier system
CCDF	Display of complementary cumulative distribution function of current signal. This function gives the probability of the magnitudes of complex I/Q samples exceeding a predefined threshold. Together with the current CCDF, the CCDFs of any number of IS-95 signals last generated can be displayed to observe the effect of parameter changes. The crest factor of the signal can be seen in the CCDF.
ACP calculation	Calculation of adjacent-channel power in spectrum display (ACP up, low and ACP up 1st alt, low 1st alt)
IF signal generation	Modulation of calculated I/Q signal to intermediate frequency in range 0.01 MHz to 25 MHz (output to I channel of R&S AMIQ)

Digital standard CDMA2000 (with option R&S AMIQ12/R&S SMIQ12)

Simulation of CDMA signals to North American standard IS-2000, available as Software Option R&S AMIQ12 of the R&S AMIQ or Software Option R&S SMIQ12 in conjunction with the Arbitrary Waveform Generator Option R&S SMIQB60 of the R&S SMIQ

General settings

Chip rate	
Standard	1.2288 Mcps (1X), 3.6864 Mcps (3X)
Range	R&S AMIQ: 10 cps to 100 Mcps R&S SMIQB60: 1 kcps to 40 Mcps
Carrier spacing	
Standard	1.25 MHz
Variable	R&S AMIQ: 0 to 10 MHz R&S SMIQB60: 0 to 2 MHz
Modes	1X Direct Spread 3X Direct Spread 3X Multi Carrier (forward link only)
Link direction	forward link and reverse link
Sequence length	entry in frames of 80 ms, max. length depending on chip rate, mode and oversampling R&S AMIQ03 (for oversampling 4): 1 to 10 frames at 1.2288 Mcps (1X) 1 to 6 frames at 3.6864 Mcps (3X) Multi Carrier 1 to 3 frames at 3.6864 Mcps (3X) Direct Spread R&S AMIQ04 (for oversampling 4): 1 to 40 frames at 1.2288 Mcps (1X) 1 to 26 frames at 3.6864 Mcps (3X) Multi Carrier 1 to 13 frames at 3.6864 Mcps (3X) Direct Spread R&S SMIQB60 (for oversampling 2 in R&S WinIQSIM™, and oversampling >4 as a result of hardware oversampling in the R&S SMIQ): 1 to 2 frames at 1.2288 Mcps (1X) 1 frame at 3.6864 Mcps (3X) Multi Carrier 1 frame at 3.6864 Mcps (3X) Direct Spread
Baseband filter	
Standard	CDMA2000 1X
Other filters	CDMA2000 3X Direct Spread same as with single-carrier system
Code channels	
Forward link	4 base stations with max. 91 code channels each (depending on radio configuration)
Reverse link	4 mobile stations with max. 13 code channels each (depending on radio configuration)

Clipping level	Setting of clipping value relative to highest peak in percent. Clipping takes place prior to baseband filtering and reduces the crest factor. The range is 1% to 100 %.
Parameters for each base station (BS)	
State	ON/OFF
Radio configuration	
Chip rate 1.2288 Mcps (1X)	RC 1 to RC 5
Chip rate 3.6864 Mcps (3X)	RC 6 to RC 9
PN offset	0 to 511
Quasi-orthogonal Walsh sets	set 1 to set 3
Channel coding	All levels of channel coding provided by IS-2000 (e.g. frame quality indicator, convolutional encoder, symbol puncture and interleaver) are available. All combinations of frame lengths and data rates are supported. Four modes are available: – off: channel coding off – complete: complete channel coding on – without interleaving: channel coding on, but without interleaver – interleaving only: channel coding off, interleaver active only
Transmit diversity (OTD)	off / antenna 1 / antenna 2 If this function is active, the output signal for antenna 1 or antenna 2 can be generated as defined in the standard.
Use TPC for dynamic output power control	ON/OFF If this function is active, the TPC pattern is used to vary the transmit power of the code channels versus time.
Output power control step	–10 dB to +10 dB
Parameters for each mobile station (MS)	
State	ON/OFF
Radio configuration	
Chip rate 1.2288 Mcps (1X)	RC 1 to RC 4
Chip rate 3.6864 Mcps (3X)	RC 5 to RC 6
Channel coding	All levels of channel coding provided by IS-2000 (e.g. frame quality indicator, convolutional encoder, symbol puncture and interleaver) are available. All combinations of frame lengths and data rates are supported. Four modes are available: – off: channel coding off – complete: complete channel coding on – without interleaving: channel coding on, but without interleaver – interleaving only: channel coding off, interleaver active only
Use TPC for dynamic output power control	ON/OFF If this function is active, the TPC pattern (selectable bit pattern, max. length 16 bit) is used to vary the transmit power of the code channels versus time.
Output power control step	–10 dB to +10 dB

Channel types	
Forward link	Special channels: – Forward Pilot (F-PICH) – Sync (F-SYNC) – Paging (F-PCH) – Transmit Diversity Pilot (F-TDPICH) – Auxiliary Pilot (F-APICH) – Auxiliary Transmit Diversity Pilot (F-ATDPCH) – Broadcast (F-BCH) – Quick Paging (F-QPCH) – Common Power Control (F-CPCCCH) – Common Assignment (F-CACH) – Forward Common Control (F-CCCH) Traffic channels: – Forward Dedicated Control (F-DCCH) – Forward Fundamental (F-FCH) – Forward Supplemental (F-SCH)
Reverse link	Special channels: – Reverse Pilot (R-PICH) – Access (R-ACH) – Enhanced Access (R-EACH) – Reverse Common Control (R-CCCH) – Reverse Dedicated Control (R-DCCH) Traffic channels: – Reverse Fundamental (R-FCH) – Reverse Supplemental Code (R-SCCH) – Reverse Supplemental 1 (R-S1CH) – Reverse Supplemental 2 (R-S2CH)
Parameters independently selectable for each forward link code channel	
State	ON/OFF
Frame length	depending on channel type and radio configuration: 5 ms, 10 ms, 20 ms, 40 ms, 80 ms
Data rate	depending on channel type and radio configuration: 1.2 kbps to max. 1036.8 kbps
Walsh code	depending on channel type and radio configuration: 0 to max. 255
Quasi-orthogonal code	ON/OFF
Long code mask	0 to 3FF FFFF FFFF hex
Power	–60 dB to 0 dB
Data	4 different data sources, 3 same as with single-carrier system, another PRBS source with differing start values for different code channels
TPC pattern	bit pattern (max. length 16 bit)
Parameters independently selectable for each reverse link code channel	
State	ON/OFF
Frame length	depending on channel type and radio configuration: 5 ms, 10 ms, 20 ms, 40 ms, 80 ms
Data rate	depending on channel type and radio configuration: 1.2 kbps to max. 1036.8 kbps
Long code mask	0 to 3FF FFFF FFFF hex
Power	–60 dB to 0 dB
Data	4 different data sources, 3 same as with single-carrier system, another PRBS source with differing start values for different code channels
Assistant functions to facilitate operation	
Parameterizable predefined settings (forward link only)	Generation of complex signal scenarios with parameterizable default settings. Selectable parameters: – use of special channels (F-PICH, F-SYNC, number of F-QPCHs) – number, frame length and data rate of data channels – crest factor: minimal/average/worst

Multichannel edit (forward link only)	Common configuration of data channels of BS channel table. Selectable parameters, partly with start value and step size: – range of data channels to be set – frame length – data rate – Walsh code with step width – state of quasi-orthogonal Walsh set – channel power with step size – data – TPC – state
Copy BS/MS	Adopting the configuration of a BS/MS for another BS/MS to define multi-BS/MS scenarios. Parameters: – source and destination of copying – Walsh code offset (forward link)
Graphical displays	
Domain conflicts (forward link only)	Display of domain conflicts (overlapping of code channels in code domain) in the channel table lines concerned. The code domain occupied by the code channels involved in the conflict can also be displayed.
Code Domain (forward link only)	Display of code domain occupied by current BS. Domain areas in which conflicts occur are highlighted. The distribution of code channels in the code domain as well as the channel powers are displayed.
Channel graph	Display of all active channels of a BS/MS versus the channel table index. The powers of the code channels are shown.
CCDF	Display of complementary cumulative distribution function of current signal. This function gives the probability of the magnitudes of complex I/Q samples exceeding a predefined threshold. Together with the current CCDF, the CCDFs of any number of CDMA2000 signals last generated can be displayed to observe the effect of parameter changes. The crest factor of the signal can be seen in the CCDF.
Constellation diagram	Display of constellation diagram versus I/Q samples of current CDMA signal. This diagram allows qualitative assessment of channel configuration, channel power ratios, and effect of selected Walsh codes.

Digital standard IEEE 802.11b Wireless LAN (with option R&S AMIQK16/SMIQK16)

Simulation of signals to Wireless LAN standard IEEE 802.11b, available as Software Option R&S AMIQK16 of the R&S AMIQ or Software Option R&S SMIQK16 in conjunction with the Arbitrary Waveform Generator Option R&S SMIQB60 of the R&S SMIQ

General settings	
Chip rate	11 Mcps
Standard	R&S AMIQ:
Range	10 cps to max. 100 Mcps R&S SMIQ (B60): 1 kcps to max. 40 Mcps

Simulation mode	framed mode: generation of a sequence of data packets with the frame structure defined by the standard, interrupted by an idle time unframed mode: generation of a non-packet-oriented signal without frame structure, with the modulation modes and data rates defined by the 802.11b standard
User data	same as with single-carrier system
Baseband filter	Gaussian, BxT = 0.3
Standard	same as with single-carrier system
Other filters	
Parameters in framed mode	
Idle time	time between two successive packets (PPDUs) in μs ; range 0 μs to 10000 μs
Number of packets	number of data packets to be generated; the minimum number of packets is 1; the maximum number depends on the packet length, idle time and oversampling
PLCP preamble and header format	long PLCP and short PLCP
PSDU bit rate	1 Mbps, 2 Mbps, 5.5 Mbps and 11 Mbps
PSDU modulation	DBPSK, DQPSK, CCK and PBCC (depending on PSDU bit rate)
PSDU data length	length of user data field in bytes of the packet to be transferred, range 0 byte to 2312 byte
Scrambling	activating or deactivating data packet scrambling
MAC header	activating and configuring the MAC header with the parameters Frame Control, Duration/ID, Address 1-4 and Sequence Control
Frame check sequence	activating or deactivating a 32 bit (4 byte) check sum for protecting the MAC header and the user data (frame body)
Power time template	automatic configuration of power ramping at the beginning and end of the data packets with shiftable start points of the ramps relative to the data packet
Parameters in unframed mode	
PSDU bit rate	1 Mbps, 2 Mbps, 5.5 Mbps and 11 Mbps
PSDU modulation	DBPSK, DQPSK, CCK and PBCC (depending on PSDU bit rate)
Sequence length	length of signal to be generated in bytes, maximum length depending on oversampling
Scrambling	activating or deactivating scrambling

Digital standard IEEE 802.11a Wireless LAN

Simulation of signals to Wireless LAN standard IEEE 802.11a, available as Software Option R&S AMIQK18 of the R&S AMIQ or Software Option R&S SMIQK18 in conjunction with the Arbitrary Waveform Generator Option R&S SMIQB60 of the R&S SMIQ.

General settings	
Kernel sample rate	20 Msps
Standard	R&S AMIQ:
Range	10 sps to max. 100 Msps R&S SMIQ (B60): 1 kcps to max. 40 Msps

Simulation mode	framed mode: generation of a sequence of data packets with the frame structure defined by the standard, interrupted by an idle time unframed mode: generation of a non-packet-oriented signal without frame structure, with the modulation modes and data rates defined by the 802.11a standard
User data	same as with single-carrier system
Baseband filter	
Standard	ideal lowpass with Hanning window
Other filters	same as with single-carrier system
Parameters in framed mode	
Idle time	time between two successive packets (PPDUs) in μ s; range 0 μ s to 10000 μ s
Number of packets	number of data packets to be generated; the minimum number of packets is 1; the maximum number depends on the packet length, idle time and oversampling
PLCP preamble	predefined according to 802.11a
PLCP SIGNAL field	automatically calculated
PSDU bit rate	6, 9, 12, 18, 24, 36, 48 and 54 Mbps
PSDU modulation	BPSK, QPSK, 16QAM or 64QAM, automatically set depending on specified PSDU bit rate
PSDU data length	length of user data field in bytes of the packet to be transferred, range 0 byte to 2312 byte, directly proportional to number of data symbols
Number of data symbols	number of OFDM symbols in data portion of packet, directly proportional to PSDU data length
Scrambling	data packet scrambling can be activated or deactivated; initial scrambler state can be set randomly or to a user-defined value
Interleaver	interleaver can be activated or deactivated
Time domain windowing	time domain windowing supported with transition times between 0 ns and 1000 ns
Service field	user-defined service field value supported
MAC header	activating and configuring the MAC header with the parameters Frame Control, Duration/ID, Address 1-4 and Sequence Control
Frame check sequence	activating or deactivating a 32 bit (4 byte) check sum for protecting the MAC header and the user data
Parameters in unframed mode	
PSDU bit rate	6, 9, 12, 18, 24, 36, 48 and 54 Mbps
PSDU modulation	BPSK, QPSK, 16QAM or 64QAM, automatically set depending on specified PSDU bit rate
PSDU data length	data length in bytes to be transferred, range 0 byte to 2312 byte, directly proportional to number of data symbols
Number of data symbols	number of OFDM symbols to be generated, directly proportional to PSDU data length
Scrambling	data scrambling can be activated or deactivated; initial scrambler state can be set randomly or to a user-defined value
Interleaver	interleaver can be activated or deactivated
Time domain windowing	time domain windowing supported with transition times between 0 ns and 1000 ns
Service field	user-defined service field value supported

Digital standard 1xEV-DO with R&S AMIQ and option R&S AMIQK17 or R&S SMIQ and options R&S SMIQK17 and R&S SMIQB60 (ARB)	
Simulation of 1xEV-DO signals to North American Standard "CDMA2000 High Rate Packet Data Air Interface Specification", available as Software Option R&S AMIQK17 of the R&S AMIQ or Software Option R&S SMIQK17 in conjunction with the Arbitrary Waveform Generator Option R&S SMIQB60 of the R&S SMIQ	
General settings	
Chip rate	
Standard	1.2288 Mcps
Range	R&S AMIQ: 10 cps to max. 100 Mcps R&S SMIQ (B60): 1 kcps to max. 40 Mcps
Link direction	forward link (simulation of up to 4 base stations) and reverse link (simulation of up to 4 mobile stations)
Sequence length	entry in frames of 26.67 ms, max. length depending on oversampling; R&S AMIQ02 and R&S AMIQ03 (for oversampling 4): 1 to 30 frames R&S AMIQ04 (for oversampling 4): 1 to 122 frames R&S SMIQB60 (for oversampling 2 in R&S WinIQSIM™ (oversampling >4 as a result of hardware oversampling in the R&S SMIQ)): 1 to 7 frames
Baseband filter	
Standard	CDMA2000 1X CDMA2000 1x + equalizer
Other filters	same as with single-carrier system
Clipping level	Setting of clipping value relative to highest peak in percent. Clipping takes place prior to baseband filtering and reduces the crest factor. The range is 1 % to 100 %.
Data sources for traffic channels	4 different data sources, 3 same as with single-carrier system, plus 1 PRBS source with differing start values for different code channels
Parameters for each base station (BS)	
State	ON/OFF
BS power	-90 dB to 0 dB
PN offset	0 to 511
Channel coding	All levels of channel coding provided by 1xEV-DO (e.g. convolutional encoder, symbol puncture and interleaver) are available. Four modes are available: -off: channel coding off -complete: complete channel coding on -without interleaving: channel coding on, but without interleaver -interleaving only: channel coding off, interleaver active only
Parameters for each mobile station (MS)	
State	ON/OFF
Mode	Access Mode Traffic Mode
Channel coding	All levels of channel coding provided by 1xEV-DO (e.g. convolutional encoder, symbol puncture and interleaver) are available. Four modes are available: - off: channel coding off - complete: complete channel coding on - without interleaving: channel coding on, but without interleaver - interleaving only: channel coding off, interleaver active only
Long code mask I/Q	0 to 3FF FFFF FFFF hex
Channel types	
Forward link	Pilot Channel, Preamble Traffic Channel MAC Reverse Activity Channel (MAC RA) up to 59 MAC Reverse Power Control Channels (MAC RPCs)

Reverse Link	Access Mode: Pilot Channel Data Channel Traffic Mode: Data Rate Control Channel (DRC) Acknowledge Channel (ACK) Pilot Channel Reverse Rate Indicator Channel (RRI) Traffic Channel
Data rates and modulation of forward traffic channel	38.4 kbps, 16 slots, QPSK 76.8 kbps, 8 slots, QPSK 153.6 kbps, 4 slots, QPSK 307.2 kbps, 2 slots, QPSK 307.2 kbps, 4 slots, QPSK 614.4 kbps, 1 slot, QPSK 614.4 kbps, 2 slots, QPSK 921.6 kbps, 2 slots, 8PSK 1228.8 kbps, 1 slot, QPSK 1228.8 kbps, 2 slots, 16QAM 1843.2 kbps, 1 slot, 8PSK 2457.6 kbps, 1 slot, 16QAM
Data rates of reverse data/traffic channel	9.6 kbps 19.2 kbps 38.4 kbps 76.8 kbps 153.6 kbps
Assistant functions to facilitate operation	
Multichannel edit (forward link MAC RPC)	Common configuration of MAC RPC channels of a BS. Selectable parameters: – range of MAC RPC channels to be set – gain and gain step – data pattern – state
Copy BS/MS	Adopting the configuration of a BS/MS for another BS/MS to define multi-BS/MS scenarios.

Import system

Import of I/Q data from other applications via a dynamic data exchange (DDE) interface or via TCP/IP ; further processing in R&S WinIQSIM™, e.g. baseband filtering or superposition of impairments	
Baseband filtering	same as with single-carrier system
Sequence length	R&S AMIQ03: 1 sample to max. 4 Msample R&S AMIQ04: 1 sample to max. 16 Msample R&S SMIQB60: 1 sample to max. 524.216 sample
Simulation of impairments and transfer characteristics	same as with single-carrier system
Smoothing	same as with single-carrier system
Graphical output	same as with single-carrier system
ACP calculation	calculation of adjacent-channel power in spectrum display (ACP up, low and ACP up 1st alt, low 1st alt)
IF signal generation	modulation of calculated I/Q signal to IF in range 0.01 MHz to 25 MHz (output to I channel of R&S AMIQ)

Miscellaneous

Waveform transmission to R&S AMIQ	interfaces: IEC/IEEE bus (GPIB), RS-232-C, floppy; conversion of I/Q signal to 14 bit R&S AMIQ format: user-selectable clipping level (over- and underranging possible)
Remote control of R&S AMIQ	download and starting of waveforms, hardware configuration, alignment and fine adjustment, file management, BER test
For data transfer	IEC/IEEE bus (GPIB): card (from National Instruments) with drivers, IEC/IEEE bus cable; RS-232-C null-modem cable
System requirements	PC compatible to industry standard, CPU clock min. 100 MHz, Windows95/98 with 32 Mbyte RAM or WindowsNT with 48 Mbyte RAM recommended, at least 50 Mbyte hard disk memory, mouse, monitor: 1024 x 768 pixels with 256 colours recommended

Ordering information

I/Q Modulation Generator	R&S AMIQ	
4 Msample		1110.2003.03
16 Msample		1110.2003.04
Internal Arbitrary Waveform Generator in the R&S SMIQ	R&S SMIQB60	1136.4390.02
Digital Standard IS-95	R&S AMIQK11	1122.2003.02
	R&S SMIQK11	1105.0287.02
CDMA2000	R&S AMIQK12	1122.2503.02
	R&S SMIQK12	1105.0435.02
WCDMA TDD Mode (3GPP)	R&S AMIQK13	1122.2603.02
	R&S SMIQK13	1105.1231.02
TD-SCDMA	R&S AMIQK14	1122.2703.02
	R&S SMIQK14	1105.1383.02
IEEE 802.11b	R&S AMIQK16	1122.2903.02
	R&S SMIQK16	1154.7700.02
IEEE 802.11a	R&S AMIQK18	1122.3100.02
	R&S SMIQK18	1154.7952.02
OFDM Signal Generation	R&S AMIQK15	1122.2803.02
	R&S SMIQK15	1105.1531.02

Certified Environmental System

ISO 14001

REG. NO 1954

Certified Quality System

ISO 9001

DQS REG. NO 1954



ROHDE & SCHWARZ